

# Good Directions Instructions Manuals

(Any Questions Please Call (888) 688 3672)

Page 2 – Large or Signature Size Assembly Instructions

Page 3 – Full Size Assembly Instructions w/ Retaining Hook

Page 4 – Full Size Assembly Instructions w/o Retaining Hook

Page 5 – Cupola Mount Assembly Instructions for Cottage Size

Page 6 – Yard and Garden Pole Assembly Instruction for  
Cottage Size

Page 7 – Roof Mount Assembly Instruction for Cottage Size

Page 8 – Weathervane Anatomy



GOOD DIRECTIONS, INC.  
ASSEMBLY INSTRUCTIONS  
**LARGE OR SIGNATURE WEATHERVANE**  
(with retaining hook)

MZ000

**BRASS DIRECTIONALS**

**COPPER BALL (LARGE)**

**SMALL ROD**

**BRASS RING**

**LARGE ROD (18")**

**ASSEMBLED VIEW**

**YOUR PACKAGE INCLUDES THE FOLLOWING PIECES:**

- 1 Figure
- 1 Large Copper Ball
- 1 Set of Brass Directionals
- 1 Brass Ring
- 1 Small Steel Threaded Rod
- 1 Large Steel Rod (18")
- 1 Retaining Hook
- 1 Tube of Loctite®

**1**

10"

**POSITION BRASS RING OVER LARGE ROD, TIGHTEN SET SCREW**

**2**

APPLY A LINE OF LOCTITE® (supplied) ACROSS THE THREADS. (This small amount is all that's needed)

THREAD SMALL ROD INTO LARGE ROD. POSITION WRENCHES ON FLAT SPOTS. TIGHTEN FIRMLY.

**TIP:** You may save the remaining LOCTITE® for other uses. Simply reverse the cap for storage

**3**

SLIDE LARGE BALL DOWN ROD TO BRASS RING.

10

**4**

INTERLOCK DIRECTIONALS, SLIDE ONTO ROD. TIGHTEN SET SCREWS.

(WEST GOES LEFT OF NORTH)

**5**

SLIDE WEATHERVANE AND RETAINING HOOK ONTO SMALL ROD SIMULTANEOUSLY. TIGHTEN SET SCREW.

Brass bottom of weathervane

Retaining hook.

APPLY COMMON GREASE TO ROD SO VANE WILL ROTATE FREELY.

FINAL STEP... SLIDE WEATHERVANE FIGURE ONTO SMALL ROD... ENJOY!



# GOOD DIRECTIONS, INC. ASSEMBLY INSTRUCTIONS FULL SIZE WEATHERVANES (with retaining hook)

COPPER SPACER BALL (SMALL)

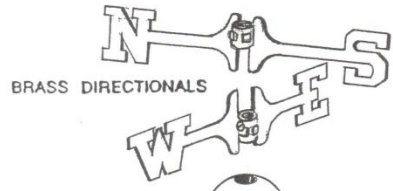

COPPER BALL (LARGE)

- YOUR PACKAGE INCLUDES THE FOLLOWING PIECES:**
- 1 Figure
  - 1 Large Copper Ball
  - 1 Set of Brass Directionals
  - 1 Brass Ring
  - 1 Small Steel Threaded Rod
  - 1 Large Steel Rod (18")
  - 1 Retaining Hook
  - 1 Tube of Loctite®

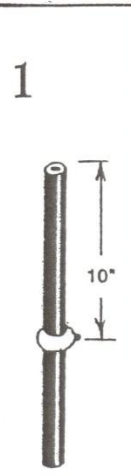
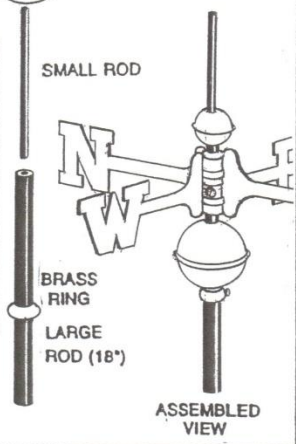

POSITION BRASS RING OVER LARGE ROD. TIGHTEN SET SCREW

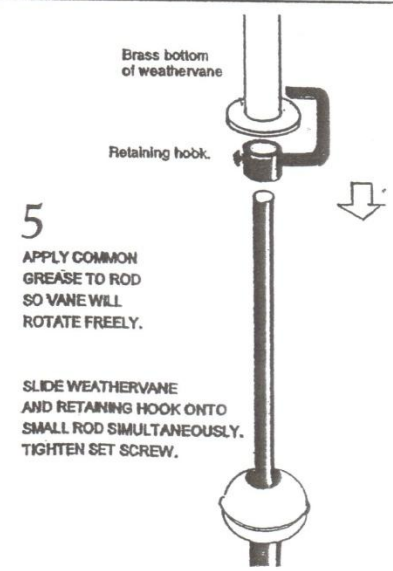
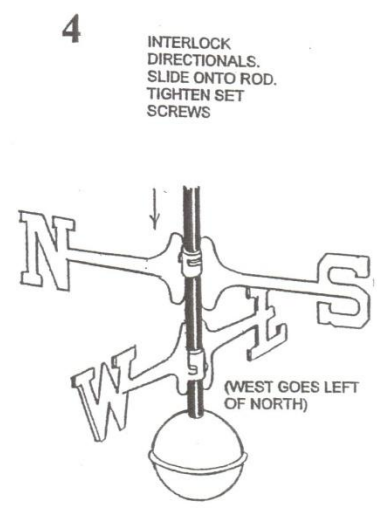
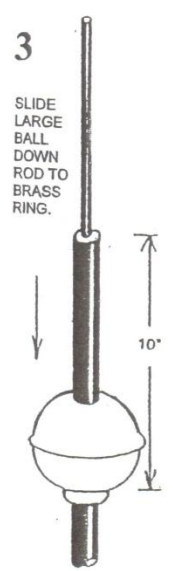
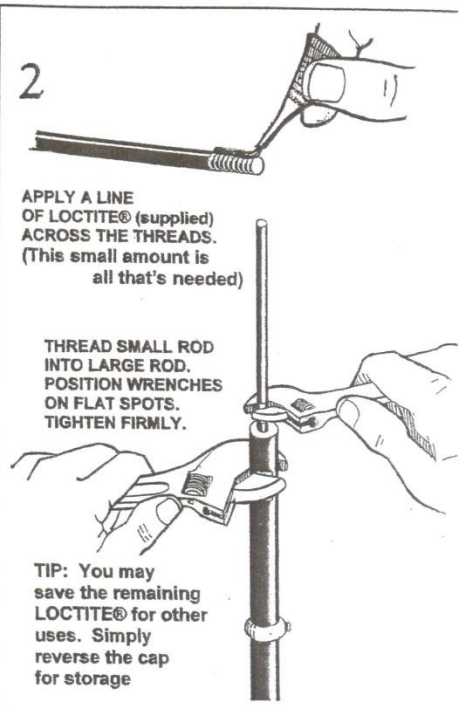



# GOOD DIRECTIONS, INC.

## ASSEMBLY INSTRUCTIONS

### FULL SIZE WEATHERVANES

A2000

COPPER SPACER BALL (SMALL)

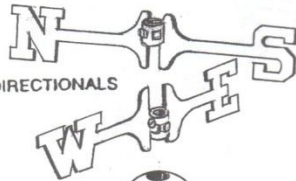

BRASS DIRECTIONALS

COPPER BALL (LARGE)



**YOUR PACKAGE INCLUDES THE FOLLOWING PIECES:**

- 1 FIGURE
- 1 Small Copper Ball
- 1 Large Copper Ball
- 1 Set of Brass Directionals
- 1 Brass Ring
- 1 Small Steel Threaded Rod
- 1 Large Steel Rod (18")
- 1 Tube of Loctite®

SMALL ROD

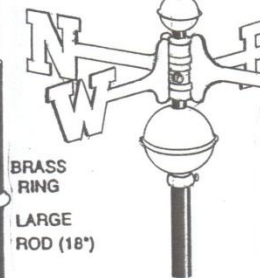

BRASS RING

LARGE ROD (18")

ASSEMBLED VIEW

1

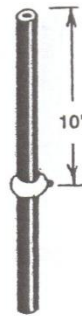

POSITION BRASS RING OVER LARGE ROD. TIGHTEN SET SCREW

2



APPLY A LINE OF LOCTITE® (supplied) ACROSS THE THREADS. (This small amount is all that's needed)

THREAD SMALL ROD INTO LARGE ROD. POSITION WRENCHES ON FLAT SPOTS. TIGHTEN FIRMLY.

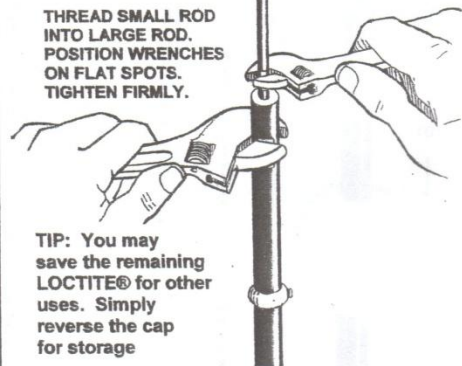

TIP: You may save the remaining LOCTITE® for other uses. Simply reverse the cap for storage

3

SLIDE LARGE BALL DOWN ROD TO BRASS RING.

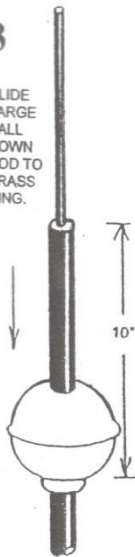

4

INTERLOCK DIRECTIONALS. SLIDE ONTO ROD. TIGHTEN SET SCREWS

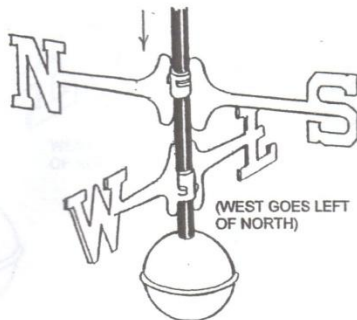

5

BRASS BOTTOM OF WEATHERVANE TUBE SLIDES OVER SMALL ROD.

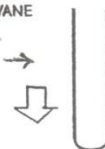

APPLY COMMON GREASE TO ROD SO VANE WILL ROTATE FREELY.

FINAL STEP... SLIDE WEATHERVANE FIGURE ONTO SMALL ROD... ENJOY!





# GOOD DIRECTIONS, INC.

## ASSEMBLY INSTRUCTIONS

### CUPOLA MOUNT INSTALLATION – COTTAGE SIZE WEATHERVANES

#### 1. ASSEMBLING TWO PART ROD

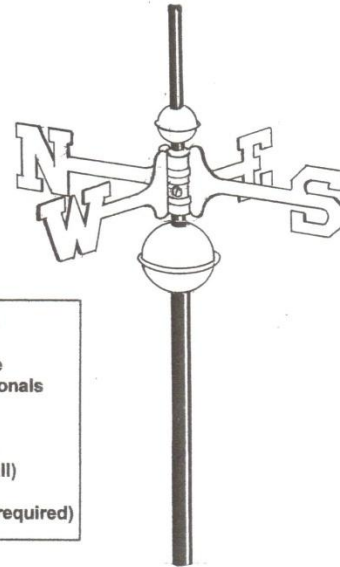
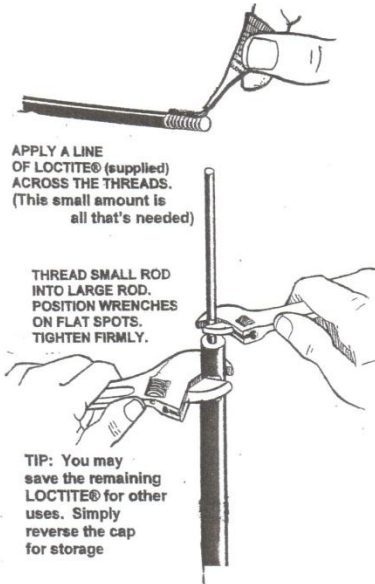

- YOUR PACKAGE INCLUDES**
- 1 Weathervane Figure
  - 1 Set of Brass Directionals
  - 1 Small Steel Rod
  - 1 Large Steel Rod
  - 1 Set of Copper Balls (one large, one small)
  - 1 Tube of Loctite®
  - 1 Retaining Hook (if required)

#### 2.



SLIDE LARGE BALL DOWN TO JUNCTION OF THE LARGE AND SMALL ROD.

#### 4. SLIDE SMALL BALL ON ROD ....REST ON DIRECTIONALS

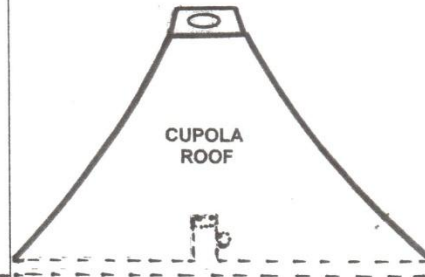
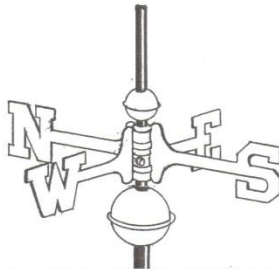

#### 3. INTERLOCK DIRECTIONALS... SLIDE ON ROD

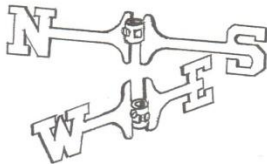

West goes left of North

#### 5. Slide weathervane onto rod.



Slide weathervane and retaining hook\* onto rod simultaneously.



Tighten set screw.

\*Retaining hook included with and required for 3-dimension figures only.

GOOD DIRECTIONS CUPOLAS ARE "WEATHERVANE READY" WITH INTERNAL MOUNTING BRACKET INSIDE ROOF.

THE WEATHERVANE ROD IS SECURED IN ROOF SECTION BEFORE THE FINAL ASSEMBLY OF CUPOLA.



# GOOD DIRECTIONS, INC.

## ASSEMBLY INSTRUCTIONS - YARD AND GARDEN POLE COTTAGE SIZE WEATHERVANES

### WEATHERVANE ASSEMBLY

1. Position brass ring over rod.
2. Slide large ball down rod to brass ring.
3. Interlock directionals... slide on rod.

west goes left of north
4. Slide small ball on rod...rest on directionals.

rounded end up

copper spacer ball (small)

copper ball (large)

brass ring
5. Slide weathervane onto rod.

Slide weathervane and retaining hook\* onto rod simultaneously.

Tighten set screw.

\*Retaining hook included with and required for 3-dimension figures only.

6. Slide weathervane rod into pole and lock using wing nut.
7. Thread section C into Section B. (See note →)
8. Thread\* section B into section A for full 55' height. (See note →)

\*Pliers may be required to tighten.

### YOUR PACKAGE INCLUDES

- 1 Weathervane Figure
- 1 Set of Brass Directionals
- 1 Weathervane Rod
- 1 Set of Copper Balls (one large, one small)
- 1 Retaining Hook (if required)
- 1 3-Piece Yard & Garden Pole

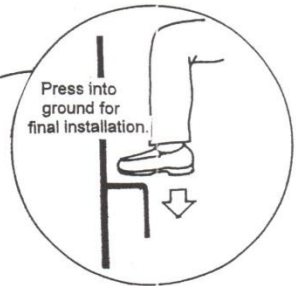
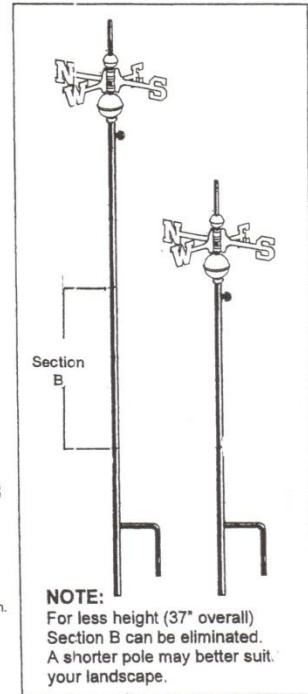



# GOOD DIRECTIONS, INC.

## ASSEMBLY INSTRUCTIONS - ROOF MOUNT INSTALLATION COTTAGE SIZE WEATHERVANES

### WEATHERVANE ASSEMBLY



1. Position brass ring over rod.



2. Slide large ball down rod to brass ring.

3. Interlock directionals... slide on rod.

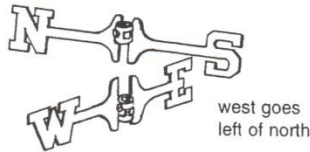

4. Slide small ball on rod...rest on directionals.

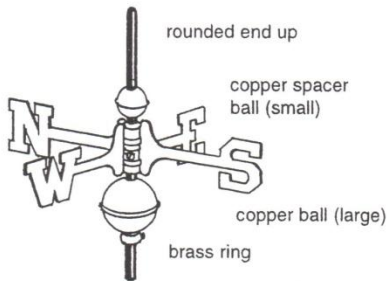

copper bottom of weathervane



5. Slide weathervane onto rod.

Slide weathervane and retaining hook\* onto rod simultaneously.

copper bottom of weathervane



retaining hook

\*Retaining hook included with and required for 3-dimension

### YOUR PACKAGE INCLUDES

- 1 Weathervane Figure
- 1 Set of Brass Directionals
- 1 Weathervane Rod
- 1 Set of Copper Balls (one large, one small)
- 1 Retaining Hook (if required)
- 1 Adjustable Roof Mount

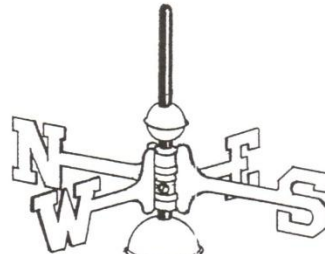

### ROOFMOUNT

Adjust roof mount to conform to your roof.



Drill 3/32" holes using roofmount as a template. Fill holes with silicone caulk and drive in 1 1/4" screws provided. Check

# WEATHER VANE ANATOMY

(CLICK TO ENLARGE FOR DETAIL)

